

Marley Stormcloud Guttering



Stormcloud Gutter System

A similar shape to traditional galvanised styles, Stormcloud is a perfect replacement for people who wish to retain the existing look of their home, whilst enjoying all the low maintenance and long life benefits of uPVC.

an Olixaxis company

Philmac[®]

The connection you can trust.



Marley Stormcloud gutter system

A similar shape to traditional galvanised styles, Stormcloud is a perfect replacement for people who wish to retain the existing look of their home, whilst enjoying all the low maintenance and long life benefits of uPVC.

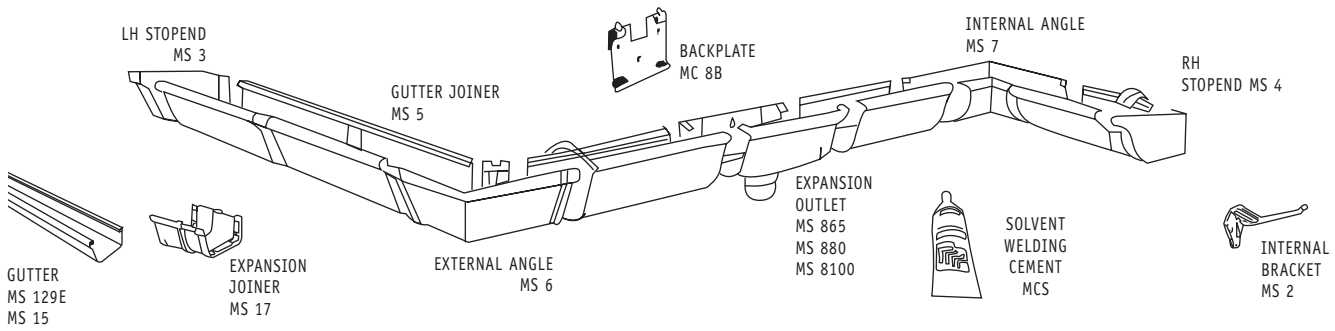

Cross-sectional area 5100mm²

Marley Stormcloud

Marley Stormcloud is a traditional style gutter that will complement any style of home.

Tough and Long-Lasting

Marley Stormcloud gutter is manufactured from uPVC. It is an extremely tough and long-lasting material that will not rust, requires little maintenance and is UV resistant.

All Marley Stormcloud components come with a 20-year guarantee.

Easy to Install











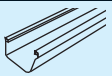
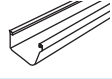
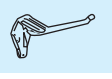

The Marley Stormcloud gutter system is a solvent-jointed system that requires no special tools. It is compatible with most downpipes and rain harvesting systems and comes with a complete range of fittings including a dropper concept for use when a rainhead is not suitable.

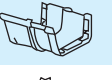
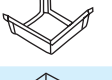
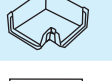
Suits any Colour Scheme

As with all the Marley gutter systems, Marley Stormcloud can be easily painted to complement any colour scheme.

DISCLAIMER

This technical catalogue has been compiled by Marley New Zealand Limited ("The Company") to promote better understanding of the technical aspects of the Company's products to assist users in obtaining from them the best possible performance. The technical catalogue is supplied subject to acknowledgment of the following conditions: The technical catalogue is protected by Copyright and may not be copied or reproduced in any form or by any means in whole or in part without prior consent in writing by the Company. Product specifications, usage data and advisory information may change from time to time with advances in research and field experience. The Company reserves the right to make such changes at any time without notice. Correct usage of the Company's products involve engineering judgements which cannot be properly made without full knowledge of all the conditions pertaining to each specific installation. The Company expressly disclaims all and any liability to any person whether supplied with this publication or not in respect of anything and of the consequences of anything done or omitted to be done by any such person in reliance whether whole or partial upon the whole or any part of the contents of this publication. No offer to trade, nor any conditions of trading, are expressed or implied by the issue or content of this manual. Nothing herein shall override the Company's Conditions of Sale, which may be obtained from the Registered Office or any Sales Office of the Company. This technical catalogue is and shall remain the property of the Company, and shall be surrendered on demand to the Company.

PRODUCT	COMPONENT	CODE	USAGE
	STORMCLOUD GUTTER 2.9m Length	MS129E	2.9m lengths
	STORMCLOUD GUTTER 5m Length	MS15	5m lengths
	GUTTER BRACKET 10 Per Packet	MS2	Allow 1 bracket for every 500mm of gutter
	LH COMBINATION STOPEND	MS3	One per LH or RH gutter end or for converting expansion outlets to LH or RH expansion stopends
	RH COMBINATION STOPEND	MS4	
	GUTTER JOINER	MS5	To join lengths of gutter
	EXPANSION JOINER	MS17	Allow 1 every 10m 8m if spouting is to be painted
	EXTERNAL ANGLE 90°	MS6	Use for 90° external corners
	INTERNAL ANGLE 90°	MS7	Use for 90° internal corners
	EXPANSION OUTLET 65mm With Backplate	MS865	Compatible with RP65 downpipes
	EXPANSION OUTLET 80mm With Backplate	MS880	Compatible with RP80 downpipes
	EXPANSION OUTLET 100 X 50mm with Backplate	MS8100	Compatible with MC140 downpipes
	BACKPLATE	MC8B	Replacement backplate
	DROPPER OUTLET 65mm, 80mm	MC1165 MC1180	Use instead of expansion outlet on short runs, eg, dormer windows
	DROPPER OUTLET 100 X 50mm	MC143	Use instead of expansion outlet on short runs, eg, dormer windows
	SOLVENT WELDING CEMENT 180g Tube	MCS	1 per 15-20m of spouting

width_18963

For further information: Philmac Pty Limited, Phone: 1800 755 899 www.philmac.com.au

an *Aliaxis* company



The connection you can trust.